

E-48 PROCESS CONTROLLER USER MANUAL



E-48 series universal process controllers are advanced new generation microcontroller based industrial instruments designed for On/Off and PID control forms, dimensions of 48x48 mm compatible with IEC/TR 60668 standart. Universal inputs and outputs of controller can be programmed easily by the user.

E-48 process controllers are equipment having high reading sensivity and capability, with no moving parts, having infinite life and very low calibration drift with time and environment conditions. Indicating method is 2x4 digit LED display. E-48 indicating range is from -1999 to 9999 and is able to connect mV, mA, thermocouple, resistance thermometer and other sensors and transmitters. Controllers have high input empedance and protecting and warning the system against the breakage sensors.

E-48 process controllers can be used in every field of the industry for the measurement and control of temperature, pressure, level, speed, current, voltage, resistance and other physical units; as well as in the industry branches of iron&steel, cement, plastic, chemistry, metallurgy, petrochemical refineries, ceramic, glass and others.

E-48 controller is designed for panel mounting and should be used in an industrial environment.

- The package of E-48 controller contains; Controller and mounting bracket User manual Guarantee certificate
- After opening the package, please check the contents with the above list. If the delivered product is wrong type, any item is missing or there are visible defects, contact the vendor from which you purchased the product.
- Before installing and operating the controller, please read the user manual thoroughly.
- The installation and configuration of the controller must only be performed by a person qualified in instrumentation.
- Keep the unit away from flammable gases, that could cause explosions.
- Do not use alcohol or other solvents to clean the controller. Use a clean cloth soaked in water tightly squeezed to gently wipe the outer surface of the controller.
- The product life of this instrument is 10 years.



- This controller complies with the European Low Voltage Directive 2006/95/EC, by the application of safety standard TS EN 61010-1. (Pollution degree 2)
- This controller complies with the EMC Directive 2004/108/EC by the application of EMC standard TS EN 61326.

TECHNICAL SPECIFICATION

Input Types	Thermocouple (TC) : B, E, J, K, L, N, R, S, T, U Resistance Thermometer (RT) : Pt-100 Current : 0-20 mA, 4-20 mA (Linear) Voltage : 0-50 mV, 0-1 V, 0.2-1 V (Linear)
Control Output	Relay : SPST-NO 250V AC, 3A Current : 0-20 mA, 4-20 mA, 20-0 mA (Isolated) Pulse : 24V DC, 25 mA (for SSR) (Not Isolated)
Alarm Outputs	Relay : SPST-NO 250V AC, 3A
Display Type	2 x 4 digit 7 mm 7 segment led display
Accuracy	Thermocouple : (±0.5% of the reading value or ±1 °C) ±1 digit max. Pt-100 : (±0.5% of the reading value or ±1 °C) ±1 digit max. Analog Input : ±0.5% FS ±1 digit max.
Analog Digital Converter	16 bit
Digital Analog Converter	12 bit
Control Type	On/Off, PID
Operating Voltage	85-265 V AC / 85-375 V DC 20-60 V AC / 20-85 V DC
Power Consumption	4W (7 VA)
Protection Class	IP 66 Front Panel (NEMA 4X) IP 20 Rear Case
Operating Temperature	-10 °C, +55 °C (+14 °F, +131 °F) (with no condensation or icing)
Storage Temperature	-25 °C, +65 °C (-13 °F, +149 °F) (with no condensation or icing)
Relay Mechanical Life	10,000,000 operations (The relay life differs according to the usage configuration. When the relays are old, their contacts could melt or burn out.)
Relay Electrical Life	>1,000,000 operations (under 1/10 of load)
Memory	EEPROM (100,000 max. write-erase)
Weight	155 g

TYPE CODING

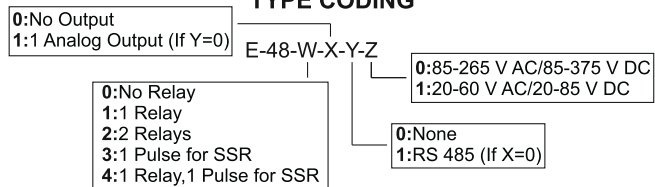

CONNECTION DIAGRAM

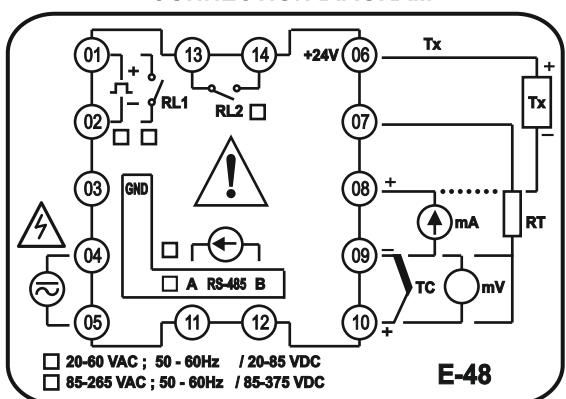

The labels on the sides of the controller identify the ordering code (Type), serial number and wiring connections. The controller options are also indicated on the wiring diagram.

- The terminals 01 to 05 are electrically live. While the instrument is powered, never touch to these terminals.
- Before operating the controller, ensure that the controller is correctly configured. Incorrect configuration could result in damage to the process being controlled.

DIMENSIONS

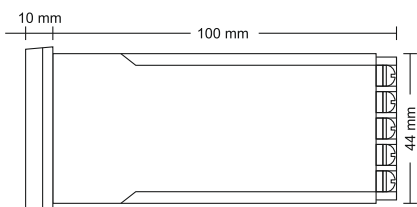
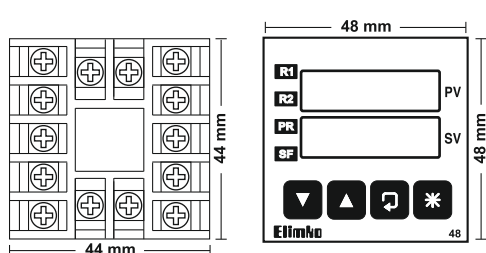

PANEL MOUNTING

- E-48 controller should be installed inside a suitable grounded metal enclosure (panel). This must prevent the live parts being accessible to human hands and metal tools.
- E-48 controller does not include a power switch. Therefore, the power supply to the controller and power outputs must be wired through the proper fuse or circuit breaker.
- To minimize the pick-up of electrical noise, the wiring of low voltage lines, particularly the sensor input should be routed away from the high-current power cables. If this is not possible use screened cables and apply grounding.
- The cables used for powering the controller and the power outputs must conform to the standards IEC 60245 and IEC 60227.

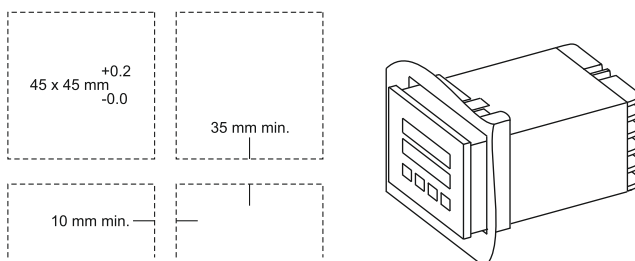

Panel Cutout and Minimum Spacing

- Cut a hole in the panel. (See the figure for overall dimensions.)
- Remove the mounting bracket and slide the controller into the cutout from the front of the panel.
- Fit the mounting bracket and slide it until the controller is fastened.

FRONT PANEL

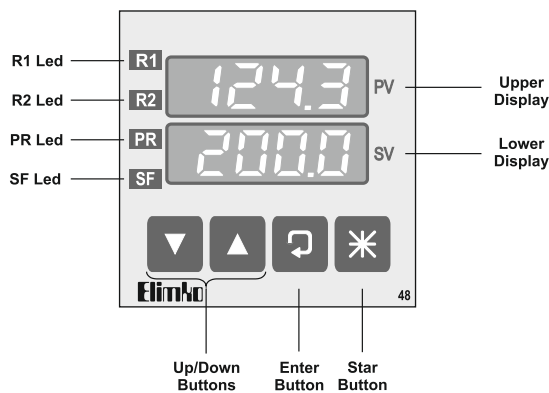

- R1 Led** When lit, it indicates that RL1 output is active.
- R2 Led** When lit, it indicates that RL2 output is active.
- PR Led** When lit, it indicates that the controller is in the configuration mode.
- SF Led**
 - When lit, it indicates that the controller is in manual mode.
 - SF led will also flash when the auto-tuning is in progress.
- Upper Display**
 - While in normal operation, it displays the process value or error message.
 - While in configuration pages, it displays the name of the parameters.
- Lower Display**
 - While in normal operation, it displays the control set point (Automatic mode) or manual output (Manual mode).
 - While in configuration pages, it displays the parameter value.
- Star Button**
 - When pressed together with button, password is asked for entering the configuration page.
 - While in configuration pages, pressing this button reverts to normal operation.
 - While in normal operation, pressing this button for duration 3 seconds, toggles between automatic and manual mode. This operation is disabled if the nPL parameter in page PrtL is set to d5b or if the LnL parameter in oLnF page is set other than P id.
 - While in normal operation, pressing this button acknowledges the latched alarms if configured (RXLt = on).
- Enter Button**
 - When pressed together with button, password is asked for entering the configuration page.
 - While in configuration pages, pressing this button selects the next parameter.
 - While in configuration pages, pressing this button for duration 2 seconds, returns to the top of the page.
 - While in normal operation, pressing this button selects the next parameter in operator page.
- Up/Down Buttons**
 - While in normal operation, these buttons can be used to edit the control set point (Automatic mode) or manual output (Manual mode).
 - While in configuration, these buttons can be used to select the configuration pages and to edit the parameters.

ALARM TYPES

R1P or R2LP	EXPLANATIONS		
	R1SP or R2SP > 0	R1SP or R2SP < 0	
Lo			Low Alarm (Absolute)
Hi			High Alarm (Absolute)
Lod			Low Deviation (Relative)
Hid			High Deviation (Relative)
LoB			Band Alarm (In)
HiB			Band Alarm (Out)
oFF	Alarm function is cancelled when R1P or R2LP parameters are oFF.		

Shaded areas show the hysteresis. When alarm state is "1" the output (relay) is active.

ERROR MESSAGES

Message	Meaning	Remedy
oPEn	The connection of the sensor is broken.	Check the sensor and the sensor connection.
uFL	The process value is below the sensor type-temperature interval.	Check the sensor and the input type specified by the InPt parameter.
oFL	The process value is above the sensor type-temperature interval.	
nnnn	The process value is above the value that can be displayed.	Check the analog value on the input terminal and the scalar specified by the dP, zErO and SPn parameters.
uuuu	The process value is below the value that can be displayed.	

INPUT TYPES and RANGES

TEMPERATURE SENSORS

Sensor Type	Standard	Temperature Range		
		(°C)	(°F)	
Type B	b	IEC 60584-1	60 , 1820	140 , 3308
Type E	E	IEC 60584-1	-200 , 840	-328 , 1544
Type J	J	IEC 60584-1	-200 , 1120	-328 , 1562
Type K	K	IEC 60584-1	-200 , 1360	-328 , 2480
Type L	L	DIN 43710	-200 , 900	-328 , 1652
Type N	n	IEC 60584-1	-200 , 1300	-328 , 2372
Type R	r	IEC 60584-1	-40 , 1760	104 , 3200
Type S	S	IEC 60584-1	-40 , 1760	104 , 3200
Type T	t	IEC 60584-1	-200 , 400	-328 , 752
Type U	u	DIN 43710	-200 , 600	-328 , 1112
Pt-100	Pt	IEC 60751	-200 , 840	-328 , 1544

LINEAR INPUTS

Type	Range
Current	0R20
Current	4R20
Voltage	0u50
Voltage	00u1
Voltage	02u1

AUTO-TUNE

- Auto-tuning matches the characteristics of the controller to the process being controlled in order to obtain good control. Tuning involves calculating and setting the values of the PID parameters. The Auto-tuner works by switching the output on and off to induce an oscillation in the process value. From the amplitude and period of oscillations PID parameters are calculated.
- Auto-tune can be performed at any time, but normally it is performed only once during the initial commissioning of the process. However, if the process under control subsequently becomes unstable (because its characteristics have changed), you can re-tune again for the new conditions.
- In order to start Auto-tune process:
 - 1- Set the LnL parameter in oLnF page as P id.
 - 2- Set the control set point to the value at which you will normally operate the process. Consider also the process value may exceed the control set point while in Auto-tuning.
 - 3- Set the HYS parameter in tUnE page as d ! (if dP=1) or ! (if dP=0).
 - 4- Set the Rt parameter in tUnE page as on to commence Auto-tuning process. Press button to revert the normal operation.
- The lower display and SF led will flash to indicate that tuning is in progress.
- After a few cycles of oscillation the tuning is completed and the calculated PID parameters Pb, It and dIt are stored.
- While the Auto-tuning in progress if Rt parameter is set the oFF or operating power of the controller is interrupted Auto-tune progress is stopped and old PID values are retained.

MANUAL TUNING

If for any reason Auto-tuning gives unsatisfactory results, the controller can be tuned manually. There are a number of standard methods for manual tuning. The one described here is the Ziegler-Nichols method. With the process at its normal running temperature:

- 1- Set the *It*, *dT* and *HYS* parameters in *tUnE* page as 0.
- 2- If *oCr* parameter in page *oCrF* is set to *rL*, then set the *LT* parameter 2.
- 3- Ignore the fact that the temperature may not settle precisely at the set point.
- 4- If the temperature is stable, reduce the proportional band *Pb* so that the temperature just starts to oscillate. If the temperature is already oscillating, increase the proportional band until it just stops oscillating. Allow enough time between each adjustment for the loop to stabilize. Make a note of the proportional band value (B) and the period of oscillation (T).
- 5- Set the *Pb*, *It* and *dT* parameters values according to the calculations given below.

Type of Control	Proportional Band (Pb)	Integral Time (It)	Derivative Time (dT)
P	2xB	0	0
PI	2.2xB	0.8xT	0
PID	1.7xB	0.5xT	0.12xT

OPERATOR PAGES

- When the controller power is switched on, it runs through a self-test sequence for about 2 seconds and displays the version number and then enters into normal operation.
- The controller has two basic modes of operation:
 - Automatic mode in which the output is automatically adjusted to maintain the process value at the control set point.
 - Manual mode in which one can adjust the output independently of the control set point.
- SF led indicates the operation mode of the controller. It lights while controller is in manual mode.
- Pressing the **☒** button for duration of 3 seconds, while in normal operation, toggles between automatic and manual mode. This operation is disabled if the *nPL* parameter in page *PrE* is set to *d5b* or if the *LnE* parameter in *oCrF* page is set other than *P id*.
- In normal operation the process value is displayed in the upper display, the control set point (Automatic mode) or manual output (Manual mode) is displayed in the lower display.
- The normal operation state and the frequently used parameters are in the operator page. These parameters can be accessed by **☐** button.
- The parameters in the operator page differ according to the operation mode.

AUTOMATIC MODE

Display	Explanation	Access Unit Conditions	Key Setting Interval
23.4	Process Value	EU	
0.0	Control Set Point	EU	☒/☒ 5PL - 5PHL
0.0	Manual Output	%	☒/☒ oLL - oHL
R 15P	Alarm-1 Set Point	EU R ItP ≠ oFF	☒/☒ +999 - 9999
R 25P	Alarm-2 Set Point	EU R 2tP ≠ oFF	☒/☒ +999 - 9999

MANUAL MODE

Display	Explanation	Access Unit Conditions	Key Setting Interval
20.0	Process Value	EU	
0.0	Manual Output	%	☒/☒ oLL - oHL
5P	Control Set Point	EU	☒/☒ 5PL - 5PHL
R 15P	Alarm-1 Set Point	EU R ItP ≠ oFF	☒/☒ +999 - 9999
R 25P	Alarm-2 Set Point	EU R 2tP ≠ oFF	☒/☒ +999 - 9999

CONFIGURATION PAGES

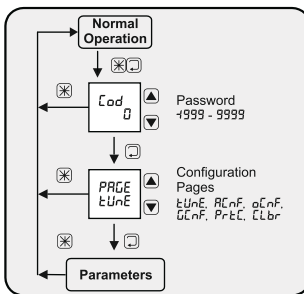

The fundamental characteristics of the controller are specified in configuration pages. These pages:

- tUnE* = PID Tuning Page
- RcNF* = Alarm Configuration Page
- oCrNF* = Control and Output Configuration Page
- GCNF* = General Configuration Page
- PrE* = Security Adjustment Page
- CLbr* = Calibration Page

Input the Configuration Pages

- In order to access the configuration pages, **☒** and **☐** buttons are pressed simultaneously.
- After this operation PR led lights and *CoD* message and **0** are displayed in the upper and lower displays respectively.
- ☒** and **☐** buttons are used to adjust the security code in the lower display. When **☐** button is pressed *tUnE* page is accessed.
- The factory setting of the security code is "10".
- The security code is defined by the parameter *5Cod* in *PrE* page.
- If the entered security code is correct all the configuration pages can be accessed and all the parameters in the configuration pages can be edited. Otherwise *dPL* and *RPL* parameters in *PrE* page define the access and edit levels of parameters.
- ☒** and **☐** buttons are used to select the configuration pages while *PRGE* message is displayed in the upper display. **☐** button select the parameters in a page sequentially. **☒** button returns to the top of the page if it pressed for duration of 2 seconds, while in configuration pages. **☒** button reverts to normal operation, while in configuration pages.

PID Tuning Page (PRGE-tUnE)

Display	Explanation	Access Unit Conditions	Key Setting Interval
Rt oFF	Auto-Tune ⁽¹⁾	<i>LnE</i> = <i>P id</i>	☒/☒ on / oFF
Pb 200	Propotional Band	EU <i>LnE</i> = <i>P id</i>	☒/☒ 0.1 - 9999
It 28	Integral Time	s <i>LnE</i> = <i>P id</i>	☒/☒ 0 - 3600
dT 7	Derivative Time	s <i>LnE</i> = <i>P id</i>	☒/☒ 0 - 3600
HYS 0.5	Hysteresis	EU <i>LnE</i> ≠ oFF	☒/☒ 0.0 - 9999

(1) Auto-tune operation is inhibited in manual mode.

Alarm Configuration Page (PRGE-RcNF)

Display	Explanation	Access Unit Conditions	Key Setting Interval
R ItP oFF	Alarm-1 Type	Table 1 <i>LnE</i> = oFF or <i>oCr</i> ≠ <i>rL</i>	☒/☒ Table 1
R ItH 0.5	Alarm-1 Hysteresis	EU R ItP ≠ oFF	☒/☒ 0.0 - 9999
R ItL oFF	Alarm-1 Lock ⁽¹⁾	R ItP ≠ oFF	☒/☒ on / oFF
R 2tP oFF	Alarm-2 Type	Table 1	☒/☒ Table 1
R 2tH 0.5	Alarm-2 Hysteresis	EU R 2tP ≠ oFF	☒/☒ 0.0 - 9999
R 2tL oFF	Alarm-2 Lock ⁽¹⁾	R 2tP ≠ oFF	☒/☒ on / oFF

(1) Pressing **☒** button acknowledges the latched alarms if *RXLt* is on while in normal operation.

Control and Output Configuration Page (PRGE-oCrNF)

Display	Explanation	Access Unit Conditions	Key Setting Interval
LnE oFF	Control Type	Table 2	☒/☒ Table 2
oCr rL	Output Circuit	Table 3 <i>LnE</i> ≠ oFF	☒/☒ Table 3
rE u	Control Form	<i>LnE</i> ≠ oFF	☒/☒ <i>dr</i> (Direct) / <i>Eu</i> (Reverse)
oLL 0.0	Minimum Output	% <i>LnE</i> = <i>P id</i>	☒/☒ 0.0 - oHL
oHL 100.0	Maximum Output	% <i>LnE</i> = <i>P id</i>	☒/☒ oLL - 100.0
b IR5 50.0	Output Offset Value	% <i>LnE</i> = <i>P id</i>	☒/☒ 0.0 - 100.0
LT 2	Control Period	s <i>LnE</i> = <i>P id</i> and <i>oCr</i> = <i>rL</i>	☒/☒ 1 - 240
nRr 0-20	mA Output Scale	mA <i>LnE</i> = oFF or <i>oCr</i> = <i>rL</i>	☒/☒ Table 3
rLl 0.0	Retransmission Low Limit	EU <i>LnE</i> = oFF or <i>oCr</i> = <i>RoC</i>	☒/☒ +999 - 9999
rHl 400.0	Retransmission High Limit	EU <i>LnE</i> = oFF or <i>oCr</i> = <i>RoC</i>	☒/☒ +999 - 9999

General Configuration Page (PRGE-GcNF)

Display	Explanation	Access Unit Conditions	Key Setting Interval
InPt H	Input Type	Table 4	☒/☒ Table 4
dP 1	Decimal Point ⁽¹⁾		☒/☒ 0 - 3
2Er o 0.0	Linear Input Scale Low Limit	EU <i>InPt</i> = Linear	☒/☒ +999 - 9999
5PRn 100.0	Linear Input Scale High Limit	EU <i>InPt</i> = Linear	☒/☒ +999 - 9999
Un It oC	Temperature Unit ⁽²⁾	<i>InPt</i> = TC / RT	☒/☒ °C (°C) / °F (°F)
InS 0.0	Input Offset Value	EU	☒/☒ +999 - 9999
FLtr 0.5	Input Filter Coefficient	EU	☒/☒ 0.1 - 10.0
Sbr H	Sensor Break Case	Table 5 <i>InPt</i> ≠ miliamper	☒/☒ Table 5
5PLL +999	Set Point Low Limit	EU	☒/☒ +999 - 5PHL
5PHL 9999	Set Point High Limit	EU	☒/☒ 5PLL - 9999
5Pr-r 0.0	Set Point Ramping Rate	EU/min	☒/☒ 0.0 - 60.0
Rr 0	Auto Return Time	s	☒/☒ 0 - 25 ⁽³⁾
FS oFF	Loading Factory Settings ⁽⁴⁾		☒/☒ on / oFF
Rdr 25	Communication Address		☒/☒ 1 - 127
brE 48	Baud Rate	kb/s	☒/☒ 48, 96, 192, 384
PrEy EuEn	Parity	Table 7	☒/☒ Table 7

- (1) When the *dP* parameter is edited, all the parameters with EU unit should be readjusted.
- (2) The EU (Engineering Unit) used in tables, thermocouples and resistance thermometer input type units °C or °F, and for linear inputs types, are the controlled measurement unit.
- (3) The value of *Rr* parameter defines the auto return time to normal operation, if there is no button operation. If it is set the zero, auto return is disabled.
- (4) The factory settings of the parameters are given in "Display" column (except the *CLbr* page). The parameter values in the *CLbr* page are the typical.

Security Adjustment Page (PRGE-PrE)

Display	Explanation	Access Unit Conditions	Key Setting Interval
dPL 4	Parameter Access Level	Table 8	☒/☒ Table 8
RPL 2	Parameter Edit Level	Table 9	☒/☒ Table 9
nPL d5b	Manual Mode Select		☒/☒ Enb (Enable) / d5b (Disable)
CLPL d5b	Calibration Page Access		☒/☒ Enb (Enable) / d5b (Disable)
5Cod 10	Password Set Value ⁽¹⁾		☒/☒ +999 - 9999

(1) Factory setting of password is "10".

Calibration Page (PRGE-CLbr)

Display	Explanation	Access Unit Conditions	Key Setting Interval
50.0	50 mV Calibration ⁽¹⁾		☒/☒ Save Calibration Value
0.0	Type K 0°C Calibration ⁽²⁾		☒/☒ Save Calibration Value
390.0	390 Ω Calibration ⁽³⁾		☒/☒ Save Calibration Value
20.0	20 mA Calibration ⁽⁴⁾		☒/☒ Save Calibration Value
R oL 75.0	Current Output Calibration (4 mA) ⁽⁵⁾		☒/☒ 600 - 900
R oH 342.4	Current Output Calibration (20 mA) ⁽⁶⁾		☒/☒ 3000 - 3800

The basic calibration of the controller is highly stable and set in the factory. Any erroneous operation in the *CLbr* page will corrupt the calibration parameter, and measurements will be faulty. The calibration parameters of the controller can be reinstalled in the *CLbr* page. If accurate calibration devices are not available, entering to the *CLbr* page is not advised.

- (1) Set the calibrator as a millivolt source and adjust the calibrator output 50.000 mV. Apply the calibrator output to the input terminals 9(-) and 10(+) of the controller. Select this parameter and press **☒** and **☒** buttons simultaneously to store the parameter.
- (2) Set the calibrator to Type K thermocouple and adjust the calibrator output 0.00 °C. Apply the calibrator output to the input terminals 9(-) and 10(+) of the controller. Select this parameter and press **☒** and **☒** buttons simultaneously to store the parameter.
- (3) Set the calibrator as a resistance source and adjust the calibrator output 390.00 Ω. Short circuit the terminals 9 and 10 of the controller. Apply the calibrator output to the input terminals 8 and 9 of the controller. Select this parameter and press **☒** and **☒** buttons simultaneously to store the parameter.
- (4) Set the calibrator as a milliampere source and adjust the calibrator output 20.00 mA. Apply the calibrator output to the input terminals 8(+) and 9(-) of the controller. Select this parameter and press **☒** and **☒** buttons simultaneously to store the parameter.
- (5) Set the calibrator as a milliampere meter. Connect the output terminals 11(+) and 12(-) of the controller to the calibrator input. Select this parameter and using **☒** and **☒** buttons adjust the parameter until the calibrator reading is equal to 4.00 mA. Press **☐** or **☒** button to store the parameter.
- (6) Set the calibrator as a milliampere meter. Connect the output terminals 11(+) and 12(-) of the controller to the calibrator input. Select this parameter and using **☒** and **☒** buttons adjust the parameter until the calibrator reading is equal to 20.00 mA. Press **☐** or **☒** button to store the parameter.

Tables

Table 1 Alarm Types

oFF	Off
Lo	Low Alarm (Absolute)
Hi	High Alarm (Absolute)
Lo d	Low Deviation (Relative)
Hi d	High Deviation (Relative)
Lo b	Band Alarm (In)
Hi b	Band Alarm (Out)

Table 6 mA Output Scale

0 - 20	0 - 20 mA
20 - 0	20 - 0 mA
4 - 20	4 - 20 mA
20 - 4	20 - 4 mA

Table 7 Parity

nonE	None
odd	Odd
EuEn	Even

Table 2 Control Types

oFF	None
oOnF	On-Off Control
P id	PID Control

Table 8 Parameter Access Level

0	Only process value can be accessed.
1	Process and set value can be accessed.
2	Operator page parameters can be accessed.
3	<i>tUnE</i> page parameters can be accessed.
4	<i>RcNF</i> page parameters can be accessed.
5	<i>oCrNF</i> page parameters can be accessed.
6	<i>GCNF</i> page parameters can be accessed.

Table 9 Parameter Edit Level

0	None of the parameters can be edited.
1	Only set value can be edited.
2	Operator page parameters can be edited.
3	<i>tUnE</i> page parameters can be edited.
4	<i>RcNF</i> page parameters can be edited.
5	<i>oCrNF</i> page parameters can be edited.
6	<i>GCNF</i> page parameters can be edited.

Table 3 Output Circuit

rL i	Relay 1
R oC	Analog Output

Table 4 Input Types

b	Type B (TC)
E	Type E (TC)
J	Type J (TC)
K	Type K (TC)
L	Type L (TC)
n	Type N (TC)
r	Type R (TC)
S	Type S (TC)
t	Type T (TC)
U	Type U (TC)
Pt	PT-100 (RT)
0R20	0-20 mA (Linear)
4R20	4-20 mA (Linear)
0.50	0-50 mV (Linear)
0.0.1	0.0-1.0 V (Linear)
0.0.2	0.2-1.0 V (Linear)

Table 5 Sensor Break Case

Lo	Lower The Process Value
Hi	Higher The Process Value

In Table 8 and Table 9 levels with arge numerals covers all previous levels.